

TAS
SCHÄFER

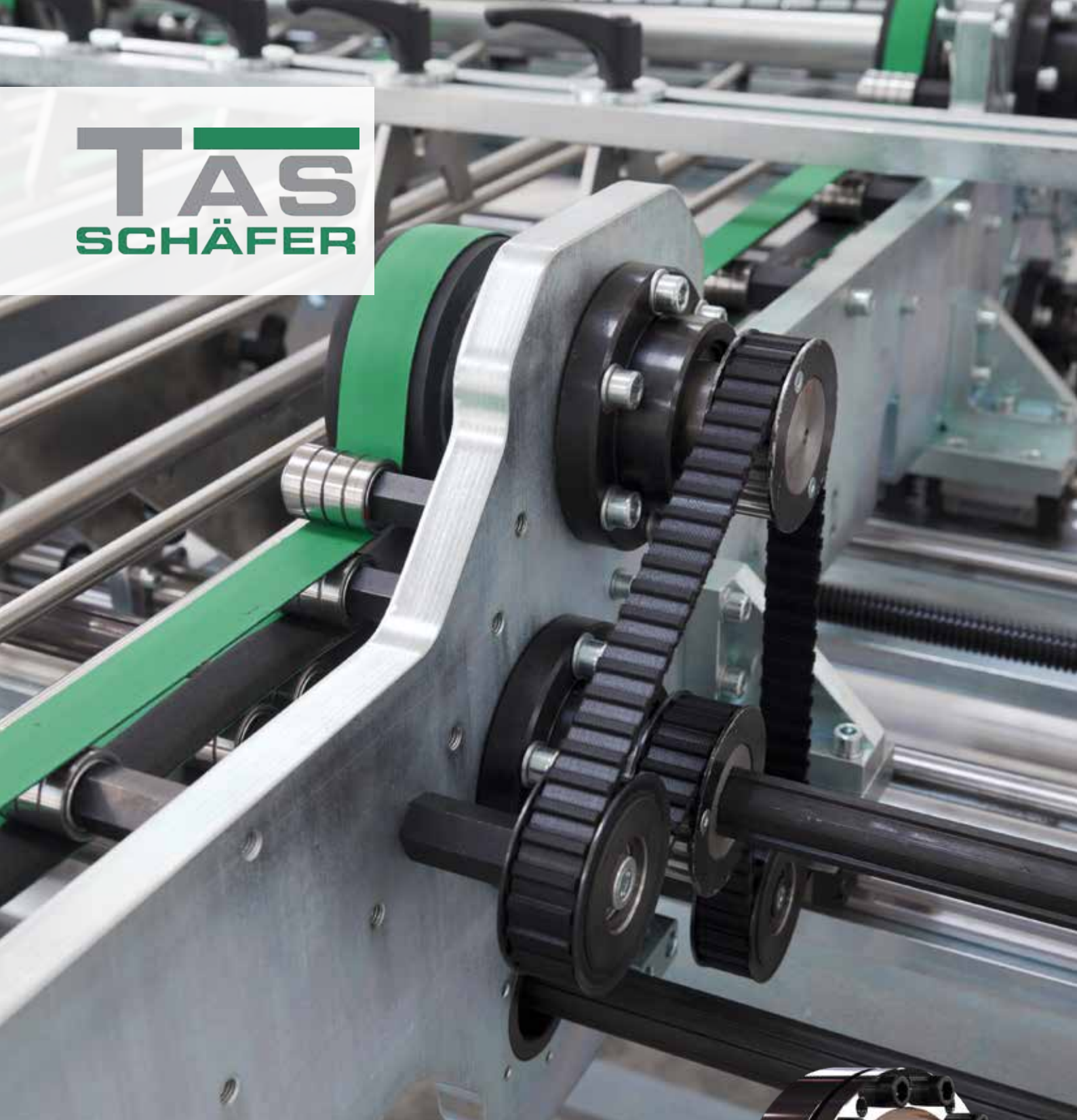

Internal Locking Devices

Shaft-Hub-Connection

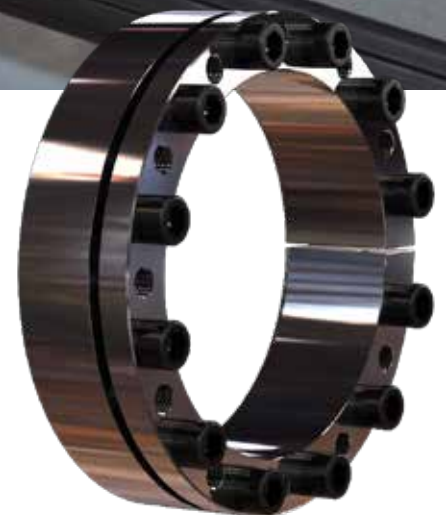

Product overview

Shaft/ Hub-connections

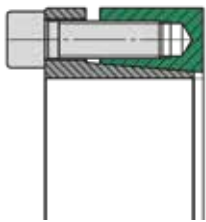

3003 plus / 3003

For low torque transmission.
For medium bending moments
Short installation length

Page 124

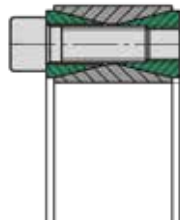

3020

For high torque transmission
Low bending moment takes place
via the hub Short installation length

Page 146

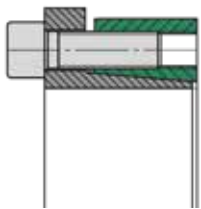

3006 plus / 3006

For medium torque transmission.
For medium bending moments
Short installation length

Page 128

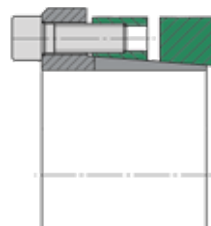

4006

For very high torque transmission.
For very high bending moments.
Wide installation length (Especially for pulley)

Page 150

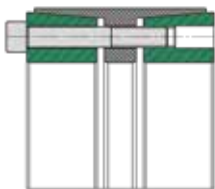

3012

For very high torque transmission.
For high bending moments
Wide installation length

Page 132



8006 (Locking elements)

For low torque transmission
Small installation space

Page 154



3014

For high torque transmission
For medium bending moments
Wide installation length

Page 134



TAS 110

For medium torque transmission.
For medium bending moments.
Small hub diameter

Page 158

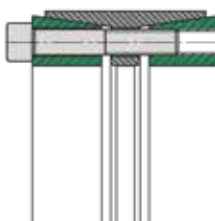

RB,3015,3015.1

For medium torque transmission.
For medium bending moments
Average installation length

Page 136

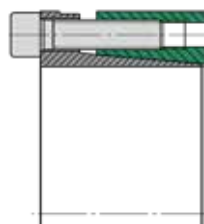

TAS 130

For medium torque transmission.
For medium bending moments.
Average installation length

Page 160

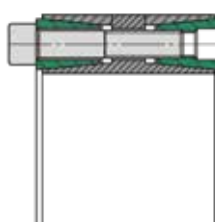

3015 DK, 3015.1 DK

For high torque transmission.
For medium bending moments.
Average installation length

Page 142

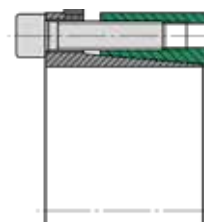

TAS 131

For medium torque transmission.
For medium bending moments.
Average installation length

Page 160

Description of function

Locking devices of the types TAS ...

The main function of a locking assembly is the safe connection of a shaft to a hub by means of friction. For example, between a shaft and a gear hub. The locking assembly creates a play-free connection by expanding between the shaft and the hub. This type of connection is used mainly for transmitting torque.

It is installed by inserting the locking assembly between the components and the subsequent tightening of the screws. By using conical surfaces, the outer diameter increases and the inner diameter reduces. Radial pressure is built up. The clamping forces are provided and controlled by the screws (force-controlled). This allows the direct compensation of the clearance between shaft and hub.

The supplied locking devices are ready for installation.

To achieve proper operation with a sufficiently high coefficient of friction, the contact surfaces between shaft and hub must be clean and slightly oiled. Machine oil must be used as a lubricant. The functional surfaces of the locking assembly, threads and screw heads are prepared at the factory with oil film.

Product data

A detailed installation manual is available on our Homepage.

Data sheets

Contact us if a data sheet for an individual product is required.

- For CAD data of couplings, contact us directly, please.

Rolf Gertner
rolf.gertner@tas-schaefer.de

or

Mike Kemper
mike.kemper@tas-schaefer.de

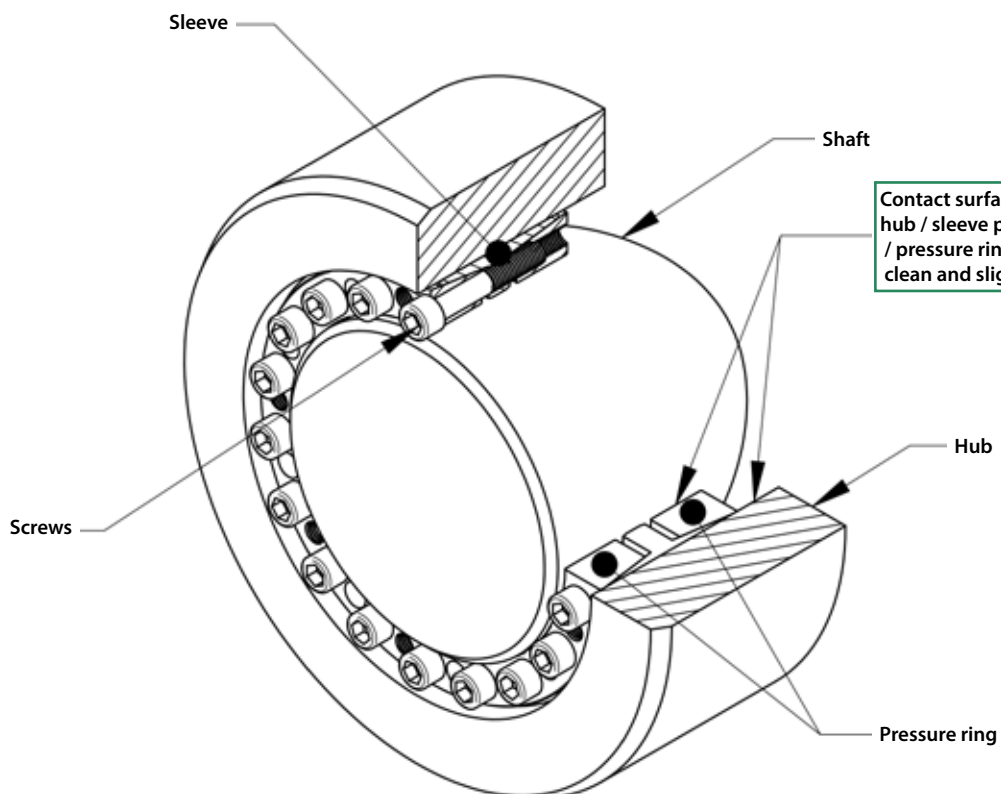

Basic-Design

Clamping length for locking devices

Pressure rings and bush of a locking device must be fully supported on the shaft and in the hub bore.

Tightening torque of the clamping screws

The tightening torque values for screws given in the tables are based on a friction $\mu_{ges} = 0,14$. Basically the specified tightening torque M_A can be reduced to M_{Agew} , to reduce the stresses in the components. When using soft materials, as well as bored shafts, it might become necessary. By reducing M_A , the pressures of P_N and P_W and the transmittable torque M_t are also reduced. The ratio is approximately proportional and can be converted accordingly (approximately):

$$M = \frac{M_{Agew}}{M_A} M_t \quad \text{and} \quad p_{N,W} = \frac{M_{Agew}}{M_A} p_{N,w}$$

The tightening torques can not be reduced arbitrary, therefore apply the following limits:

$$M_{Agew} \geq \begin{pmatrix} \text{Class 8.8: } 0,85 M_A \\ \text{Class 10.9: } 0,70 M_A \\ \text{Class 12.9: } 0,60 M_A \end{pmatrix} \leq M_A$$

Locking assemblies of type RB, 3015.1 and 3015.1 DK are excluded because they are already provided with reduced values.

Tolerances and surfaces

The values found in the product data, base on surface quality and tolerances according to the tables there. These values are given as recommendations.

Higher surface roughness reduces the transmissible torque and promote unwanted settlings. Larger clearance also reduces the transmissible torque.

In case of significantly differnt values, please contact us!

The calculation of the values, given in the catalog, are based on the following assumptions and simplification:

Transmissible torque

A connection by locking assembly is capable of transmitting torque, bending moment and axial force. Alternatively, the transmissible torque M_{max} is specified in the product data. If such loads occur simultaneously, they must be added vectorially to form a resultant moment M_{res} . For the resultant moment applies:

$$M_{res} \leq M_{max}$$

At different load cases, these are individually checked against M_{max} !

M_{res} is determined for combined load as follows:

$$M_{res} = \sqrt{M_T^2 + 2M_B^2 + (F_{AX} \frac{d_W}{2})^2}$$

*Basically the maximum bending moment corresponds to the maximum transmissible torque. A limitation is due to the change of the surface pressure at the edges of the connection, or by the higher loading of the locking assembly itself. Appropriate limits are found under each product. (See also under „bending moment“)

This results in the following relationships:

Torque only:

The maximum torque is equivalent to M_{max} .

Bending moment only:

The Bending moment corresponds with the indicated portion of M_T , on the product page.

Axial force only:

The maximum axial force is $M_{max} \frac{2}{d_W}$.

Depending on the application, additional safety factors need to be considered for the individual loads!



Basics-Calculation

Radial Force:

Radial forces cause a change in pressure at the contact surface. In the force direction, the pressure increases on one side and is reduced accordingly on the other side. This depends on the amount of radial force and the rigidity of the parts. The following equation can be used to approximate the pressure change:

$$\Delta p_w = 0,75 \frac{F_{AX}}{d_w I_K}$$

The modified pressures $p_{wmin, max}$ results from the following equation:

$$p_{wmin, max} = p_w \pm \Delta p_w$$

The minimum pressure p_{wmin} should be at least 30 N/mm² to avoid gap corrosion. In addition, the material must be selected for a maximum pressure p_{wmax} .

Bending moment

Here the situation is similar to the radial forces. The pressure is greatest at the ends of the connection in this case. Again, the amount and stiffness are important. This leads to the following approximation:

$$\Delta p_{w, N} = 4,5 \frac{M_B}{d_w I_K^2}$$

As before, the modified pressures results from:

$$p_{w, Nmin, max} = p_{w, N} \pm \Delta p_{w, N}$$

The conditions for minimum and maximum pressure are the same as before. It should be noted that there could be a change in pressure due to radial force!



Shaft and hub calculation

The catalogue contains information about the generated surface pressure of each locking assembly. Due to the generated radial pressure the hub is deformed, whereupon resilience of the shaft and surface smoothing still has to be added. For solid shafts resilience is negligible but has to be considered for hollow shafts. They are showing greater deformation and therefore greater stresses. This should be considered in addition to the other loads.

The equivalent stresses in the hub can be determined according to various hypotheses such as GEH. On the following pages you will find tables showing required hub sizes, taking pressure, shape and yield strength of hub material into consideration. The shown values for hub sizes are only valid for a solid hub cross-section! The calculation is simplified, includes no additional safety and covers the range of static loads only. Various calculation methods for different cases can be found in mechanical-engineering literature. Specialized software allows the same. For complex geometry reliable results can be determined only by verified FEA.

The minimum yield strength of solid shafts should be at least 2 * PW, the yield point of hub material at least 1 * PN. These values are for orientation only, represent minimum requirements and cannot replace calculations for each application! They also do not release from doing so!

Notch effect

Generally there is a notch effect on the components, caused by the radial pressure of the locking device. This depends mainly on the applied pressure. On the shaft the notch effect is usually much higher than at the hub, as the pressure is higher here. The factors are in the range of 1.2 to 1.8 at the shaft. This can, for example, be mitigated by appropriate design details, such as relief notches.

Bore in the shaft (Hollow shaft)

A large bore d_b in the shaft or use of a hollow shaft, reduces the stiffness of this component against radial pressure. Basically, a bore should not be greater than 0,3 d_w .

Hub-Calculation

The K-Values can directly be taken from the tables or can be calculated as follows:

When using TAS Locking assemblies a tension is generated by the surface pressure p_n between locking assembly and hub. The required hub diameter is calculated using the same formula, as used for thick-walled hollow cylinder. The real tensions depend on the hub length and shape with respect to the length L of the locking assemblies. Depending on the type of hub, the factor C is taken into account for calculation.

$$D_N \geq D \cdot K \quad K = \frac{\sigma_{02} + (C \cdot p_n)}{\sqrt{\sigma_{02} - (C \cdot p_n)}}$$

$B \geq 2 L$

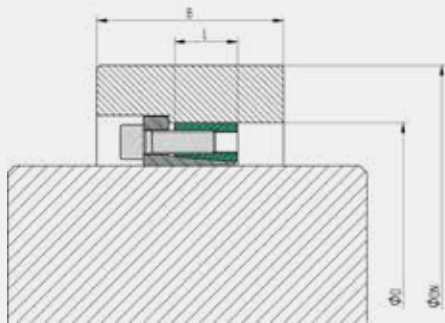

$C = 0,6$

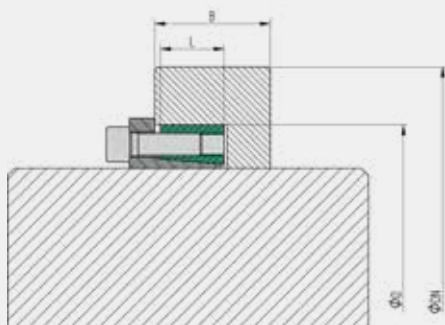
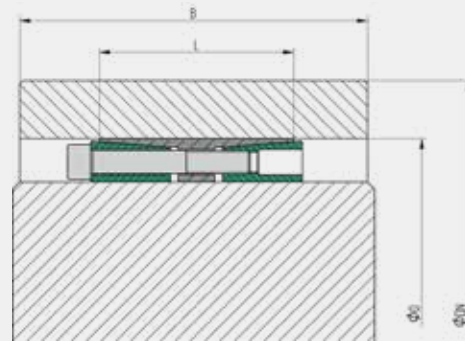

$C = 0,8$

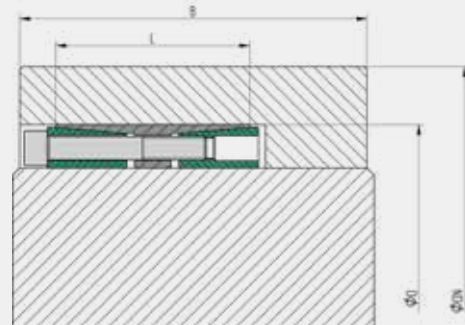

$B \geq L$

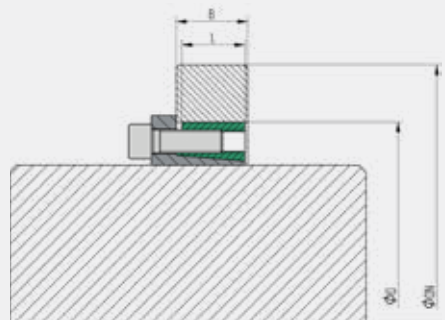

$C = 1,0$

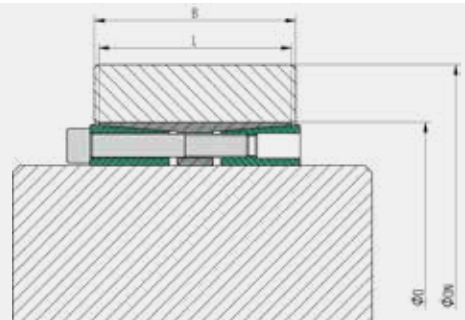

Hub Outside Diameter

P_N N/mm ²	K-Factor for hubtype with C = 0,6										
	Yield strength hubmaterial (N/mm ²)										
	150	180	210	240	270	300	330	360	390	420	450
50	1,225	1,184	1,155	1,134	1,119	1,106	1,096	1,088	1,081	1,075	1,070
55	1,251	1,204	1,172	1,149	1,131	1,117	1,106	1,097	1,089	1,082	1,077
60	1,278	1,225	1,190	1,164	1,144	1,129	1,116	1,106	1,097	1,090	1,084
65	1,305	1,247	1,207	1,179	1,157	1,140	1,127	1,115	1,106	1,098	1,091
70	1,334	1,269	1,225	1,194	1,170	1,152	1,137	1,125	1,115	1,106	1,099
75	1,363	1,291	1,244	1,209	1,184	1,164	1,148	1,134	1,123	1,114	1,106
80	1,394	1,315	1,262	1,225	1,197	1,176	1,158	1,144	1,132	1,122	1,114
85	1,425	1,339	1,282	1,241	1,211	1,188	1,169	1,154	1,141	1,130	1,121
90	1,458	1,363	1,301	1,258	1,225	1,200	1,180	1,164	1,150	1,139	1,129
95	1,492	1,389	1,322	1,274	1,240	1,213	1,191	1,174	1,159	1,147	1,136
100	1,528	1,415	1,342	1,291	1,254	1,225	1,202	1,184	1,168	1,155	1,144
105	1,565	1,442	1,363	1,309	1,269	1,238	1,214	1,194	1,177	1,164	1,152
110	1,604	1,469	1,385	1,327	1,284	1,251	1,225	1,204	1,187	1,172	1,160
115	1,645	1,498	1,407	1,345	1,299	1,264	1,237	1,215	1,196	1,181	1,168
120	1,688	1,528	1,430	1,363	1,315	1,278	1,249	1,225	1,206	1,190	1,176
125	1,733	1,559	1,453	1,382	1,331	1,291	1,261	1,236	1,215	1,198	1,184
130	1,780	1,591	1,478	1,402	1,347	1,305	1,273	1,247	1,225	1,207	1,192
135	1,830	1,624	1,502	1,421	1,363	1,319	1,285	1,258	1,235	1,216	1,200
140	1,883	1,659	1,528	1,442	1,380	1,334	1,298	1,269	1,245	1,225	1,208
145	1,940	1,695	1,554	1,462	1,397	1,348	1,310	1,280	1,255	1,234	1,217
150	-	1,733	1,582	1,484	1,415	1,363	1,323	1,291	1,265	1,244	1,225
155	-	1,772	1,610	1,506	1,433	1,378	1,336	1,303	1,276	1,253	1,234
160	-	1,813	1,639	1,528	1,451	1,394	1,350	1,315	1,286	1,262	1,242
165	-	1,856	1,669	1,551	1,469	1,409	1,363	1,327	1,297	1,272	1,251
170	-	1,902	1,700	1,575	1,489	1,425	1,377	1,339	1,308	1,282	1,260
175	-	1,950	1,733	1,599	1,508	1,442	1,391	1,351	1,318	1,291	1,269
180	-	-	1,766	1,624	1,528	1,458	1,405	1,363	1,329	1,301	1,278
185	-	-	1,801	1,650	1,548	1,475	1,420	1,376	1,341	1,311	1,287
190	-	-	1,838	1,677	1,569	1,492	1,434	1,389	1,352	1,322	1,296
195	-	-	1,876	1,704	1,591	1,510	1,449	1,402	1,363	1,332	1,305
200	-	-	1,915	1,733	1,613	1,528	1,464	1,415	1,375	1,342	1,315
205	-	-	1,957	1,762	1,636	1,546	1,480	1,428	1,387	1,353	1,324
210	-	-	-	1,792	1,659	1,565	1,496	1,442	1,399	1,363	1,334
215	-	-	-	1,824	1,683	1,584	1,512	1,455	1,411	1,374	1,344
220	-	-	-	1,856	1,707	1,604	1,528	1,469	1,423	1,385	1,353
225	-	-	-	1,890	1,733	1,624	1,545	1,484	1,435	1,396	1,363
230	-	-	-	1,926	1,759	1,645	1,562	1,498	1,448	1,407	1,373
235	-	-	-	1,962	1,785	1,666	1,579	1,513	1,461	1,419	1,383
240	-	-	-	-	1,813	1,688	1,597	1,528	1,474	1,430	1,394
245	-	-	-	-	1,842	1,710	1,615	1,543	1,487	1,442	1,404
250	-	-	-	-	1,871	1,733	1,633	1,559	1,500	1,453	1,415

Hub Outside Diameter

K-Factor for hubtype with C = 0,8

Yield strength hubmaterial (N/mm²)

p_N N/mm ²	Yield strength hubmaterial (N/mm ²)										
	150	180	210	240	270	300	330	360	390	420	450
50	1,315	1,254	1,213	1,184	1,161	1,144	1,130	1,119	1,109	1,101	1,094
55	1,353	1,284	1,237	1,204	1,179	1,160	1,144	1,131	1,120	1,111	1,104
60	1,394	1,315	1,262	1,225	1,197	1,176	1,158	1,144	1,132	1,122	1,114
65	1,436	1,347	1,288	1,247	1,216	1,192	1,173	1,157	1,144	1,133	1,124
70	1,481	1,380	1,315	1,269	1,235	1,208	1,187	1,170	1,156	1,144	1,134
75	1,528	1,415	1,342	1,291	1,254	1,225	1,202	1,184	1,168	1,155	1,144
80	1,578	1,451	1,370	1,315	1,274	1,242	1,218	1,197	1,181	1,166	1,154
85	1,631	1,489	1,400	1,339	1,294	1,260	1,233	1,211	1,193	1,178	1,165
90	1,688	1,528	1,430	1,363	1,315	1,278	1,249	1,225	1,206	1,190	1,176
95	1,748	1,569	1,461	1,389	1,336	1,296	1,265	1,240	1,219	1,201	1,186
100	1,813	1,613	1,494	1,415	1,358	1,315	1,281	1,254	1,232	1,213	1,197
105	1,883	1,659	1,528	1,442	1,380	1,334	1,298	1,269	1,245	1,225	1,208
110	1,960	1,707	1,563	1,469	1,403	1,353	1,315	1,284	1,259	1,237	1,220
115	2,043	1,759	1,600	1,498	1,427	1,373	1,332	1,299	1,272	1,250	1,231
120	2,135	1,813	1,639	1,528	1,451	1,394	1,350	1,315	1,286	1,262	1,242
125	2,237	1,871	1,679	1,559	1,476	1,415	1,368	1,331	1,300	1,275	1,254
130	2,350	1,934	1,722	1,591	1,502	1,436	1,386	1,347	1,315	1,288	1,266
135	2,479	2,000	1,766	1,624	1,528	1,458	1,405	1,363	1,329	1,301	1,278
140	2,626	2,073	1,813	1,659	1,555	1,481	1,424	1,380	1,344	1,315	1,290
145	2,798	2,151	1,863	1,695	1,584	1,504	1,444	1,397	1,359	1,328	1,302
150	-	2,237	1,915	1,733	1,613	1,528	1,464	1,415	1,375	1,342	1,315
155	-	2,330	1,971	1,772	1,643	1,553	1,485	1,433	1,391	1,356	1,327
160	-	2,434	2,031	1,813	1,675	1,578	1,506	1,451	1,407	1,370	1,340
165	-	2,550	2,094	1,856	1,707	1,604	1,528	1,469	1,423	1,385	1,353
170	-	2,680	2,163	1,902	1,741	1,631	1,550	1,489	1,440	1,400	1,367
175	-	2,829	2,237	1,950	1,776	1,659	1,573	1,508	1,457	1,415	1,380
180	-	-	2,316	2,000	1,813	1,688	1,597	1,528	1,474	1,430	1,394
185	-	-	2,403	2,054	1,852	1,717	1,621	1,548	1,492	1,446	1,408
190	-	-	2,499	2,111	1,892	1,748	1,646	1,569	1,510	1,461	1,422
195	-	-	2,604	2,172	1,934	1,780	1,672	1,591	1,528	1,478	1,436
200	-	-	2,721	2,237	1,978	1,813	1,698	1,613	1,547	1,494	1,451
205	-	-	2,852	2,306	2,024	1,848	1,726	1,636	1,566	1,511	1,466
210	-	-	-	2,381	2,073	1,883	1,754	1,659	1,586	1,528	1,481
215	-	-	-	2,462	2,124	1,921	1,783	1,683	1,606	1,546	1,496
220	-	-	-	2,550	2,179	1,960	1,813	1,707	1,627	1,563	1,512
225	-	-	-	2,646	2,237	2,000	1,844	1,733	1,648	1,582	1,528
230	-	-	-	2,752	2,298	2,043	1,877	1,759	1,670	1,600	1,544
235	-	-	-	2,869	2,364	2,088	1,910	1,785	1,692	1,619	1,561
240	-	-	-	-	2,434	2,135	1,945	1,813	1,715	1,639	1,578
245	-	-	-	-	2,510	2,184	1,982	1,842	1,738	1,659	1,595
250	-	-	-	-	2,592	2,237	2,020	1,871	1,763	1,679	1,613

Hub Outside Diameter

K-Factor for hubtype with C = 1,0											
p_N	Yield strength hubmaterial (N/mm ²)										
	150	180	210	240	270	300	330	360	390	420	450
50	1,415	1,331	1,275	1,236	1,207	1,184	1,165	1,151	1,138	1,128	1,119
55	1,469	1,372	1,308	1,263	1,230	1,204	1,184	1,167	1,153	1,141	1,131
60	1,528	1,415	1,342	1,291	1,254	1,225	1,202	1,184	1,168	1,155	1,144
65	1,591	1,460	1,378	1,321	1,279	1,247	1,221	1,201	1,184	1,169	1,157
70	1,659	1,508	1,415	1,351	1,304	1,269	1,241	1,218	1,199	1,184	1,170
75	1,733	1,559	1,453	1,382	1,331	1,291	1,261	1,236	1,215	1,198	1,184
80	1,813	1,613	1,494	1,415	1,358	1,315	1,281	1,254	1,232	1,213	1,197
85	1,902	1,671	1,537	1,449	1,386	1,339	1,302	1,273	1,248	1,228	1,211
90	2,000	1,733	1,582	1,484	1,415	1,363	1,323	1,291	1,265	1,244	1,225
95	2,111	1,799	1,629	1,520	1,445	1,389	1,345	1,311	1,283	1,259	1,240
100	2,237	1,871	1,679	1,559	1,476	1,415	1,368	1,331	1,300	1,275	1,254
105	2,381	1,950	1,733	1,599	1,508	1,442	1,391	1,351	1,318	1,291	1,269
110	2,550	2,036	1,789	1,641	1,542	1,469	1,415	1,372	1,337	1,308	1,284
115	2,752	2,131	1,850	1,686	1,577	1,498	1,439	1,393	1,356	1,325	1,299
120	3,000	2,237	1,915	1,733	1,613	1,528	1,464	1,415	1,375	1,342	1,315
125	3,317	2,355	1,986	1,782	1,651	1,559	1,490	1,437	1,395	1,360	1,331
130	3,742	2,490	2,062	1,835	1,691	1,591	1,517	1,460	1,415	1,378	1,347
135	4,359	2,646	2,145	1,890	1,733	1,624	1,545	1,484	1,435	1,396	1,363
140	5,386	2,829	2,237	1,950	1,776	1,659	1,573	1,508	1,457	1,415	1,380
145	7,682	3,048	2,337	2,014	1,823	1,695	1,603	1,533	1,478	1,434	1,397
150	-	3,317	2,450	2,082	1,871	1,733	1,633	1,559	1,500	1,453	1,415
155	-	3,661	2,577	2,156	1,923	1,772	1,665	1,585	1,523	1,474	1,433
160	-	4,124	2,721	2,237	1,978	1,813	1,698	1,613	1,547	1,494	1,451
165	-	4,796	2,887	2,324	2,036	1,856	1,733	1,641	1,571	1,515	1,469
170	-	5,917	3,083	2,421	2,098	1,902	1,768	1,671	1,596	1,537	1,489
175	-	8,427	3,317	2,527	2,165	1,950	1,806	1,701	1,622	1,559	1,508
180	-	-	3,606	2,646	2,237	2,000	1,844	1,733	1,648	1,582	1,528
185	-	-	3,975	2,780	2,314	2,054	1,885	1,765	1,675	1,605	1,548
190	-	-	4,473	2,933	2,398	2,111	1,928	1,799	1,703	1,629	1,569
195	-	-	5,197	3,110	2,490	2,172	1,973	1,835	1,733	1,654	1,591
200	-	-	6,404	3,317	2,592	2,237	2,020	1,871	1,763	1,679	1,613
205	-	-	9,111	3,566	2,704	2,306	2,069	1,910	1,794	1,705	1,636
210	-	-	-	3,873	2,829	2,381	2,122	1,950	1,826	1,733	1,659
215	-	-	-	4,267	2,970	2,462	2,177	1,992	1,860	1,760	1,683
220	-	-	-	4,796	3,131	2,550	2,237	2,036	1,895	1,789	1,707
225	-	-	-	5,568	3,317	2,646	2,300	2,082	1,931	1,819	1,733
230	-	-	-	6,856	3,536	2,752	2,367	2,131	1,969	1,850	1,759
235	-	-	-	9,747	3,799	2,869	2,439	2,182	2,009	1,882	1,785
240	-	-	-	-	4,124	3,000	2,517	2,237	2,050	1,915	1,813
245	-	-	-	-	4,539	3,148	2,601	2,294	2,093	1,950	1,842
250	-	-	-	-	5,100	3,317	2,693	2,355	2,139	1,986	1,871

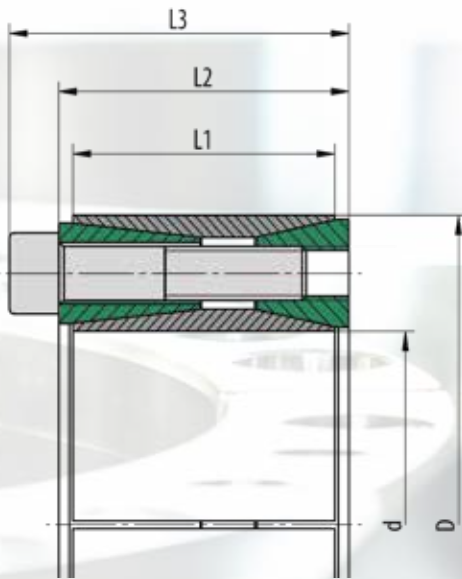

Used symbols

d	[mm]	Shaft diameter
D	[mm]	Hub inside diameter
M_t	[Nm]	Max. transmittable torque $F_{ax} = 0$
F_{ax}	[kN]	Max. transmittable axial force $M_t = 0$
p_w	[N/mm ²]	Average pressure on the shaft
p_N	[N/mm ²]	Average pressure on the hub
L_1	[mm]	Length of the sleeve inside and outside
L_2	[mm]	Width of the locking device without screws
L_3	[mm]	Width of the locking device with screws
Z		Number of clamping screws
S		Size of the clamping screws
M_A	[Nm]	Tightening torque of the clamping screws

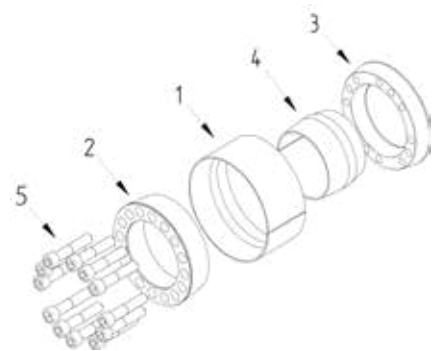

Recommended tolerances & surfaces

Shaft	k9-h9 / Rz10
Hub	N9-H9 / Rz10

Bending loads

Bending moment (share)	$M_B \max = 0,3 * M_t$
Bending angle	max. 5'

More properties

- no axial displacement during assembly
- very good self-centering
- low self-locking

Pos.	Designation
1	Sleeve outside
2	Pressure ring 1
3	Pressure ring 2
4	Sleeve inside
5	Screw

In order to be able to dismantle these clamping sets, the back pressure ring pos. 3 must bear against a stop



Ordering information: TAS 3014/d/D (e.g. TAS 3014/150/200 ... further sizes on request)

3014

d mm	D mm	M_t Nm	F_{ax} kN	P_w N/mm ²	P_N N/mm ²	Z Pcs.	S	M_A Nm	L₁ mm	L₂ mm	L₃ mm	Weight kg	
70	x	120	7136	204	206	120	8	M12 x 055	145	56	62	74	3,2
80	x	130	12233	306	271	166	12	M12 x 055	145	56	62	74	3,6
90	x	140	13762	306	240	155	12	M12 x 055	145	56	62	74	3,9
100	x	160	20967	419	219	137	12	M14 x 070	235	72	82	96	7,0
110	x	170	26908	489	233	151	14	M14 x 070	235	72	82	96	7,5
120	x	180	31450	524	228	152	15	M14 x 070	235	72	82	96	8,0
130	x	190	34071	524	211	144	15	M14 x 070	235	72	82	96	8,5
140	x	200	41585	594	222	155	17	M14 x 070	235	72	82	96	9,1
150	x	210	47176	629	219	151	18	M14 x 070	235	72	82	96	9,6
160	x	230	65643	821	231	161	17	M16 x 080	365	84	94	110	13,8
170	x	240	73848	869	230	163	18	M16 x 080	365	84	94	110	14,5
180	x	250	86880	965	241	174	20	M16 x 080	365	84	94	110	15,3
190	x	260	96292	1014	240	175	21	M16 x 080	365	84	94	110	16,0
200	x	270	111013	1110	250	185	23	M16 x 080	365	84	94	110	17,0
220	x	300	135579	1233	198	145	21	M18 x 100	500	105	116	134	27,0
240	x	320	169033	1408	208	156	24	M18 x 100	500	105	116	134	29,2
260	x	340	183119	1409	192	147	24	M18 x 100	500	105	116	134	31,3
280	x	370	252994	1807	194	147	24	M20 x 120	710	125	136	156	45,0
300	x	390	271065	1807	181	139	24	M20 x 120	710	125	136	156	47,7



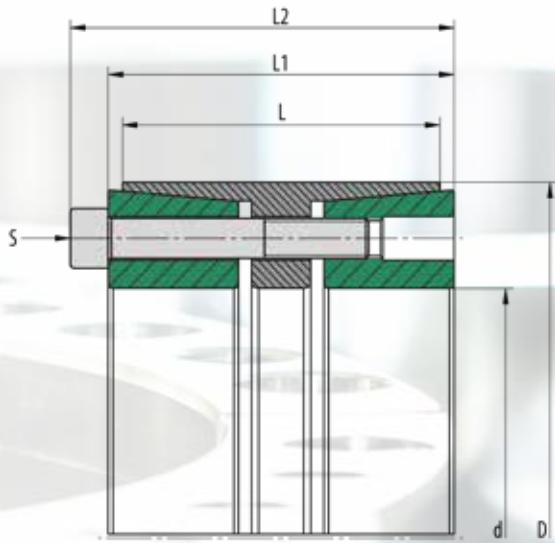

Used symbols

d	[mm]	Shaft diameter	
D	[mm]	Hub inside diameter	
M_t	[Nm]	Max. transmittable torque	$F_{ax} = 0$
F_{ax}	[kN]	Max. transmittable axial force	$M_t = 0$
p_w	[N/mm ²]	Average pressure on the shaft	
p_h	[N/mm ²]	Average pressure on the hub	
L	[mm]	Length of the sleeve	
L_1	[mm]	Width of the locking device without screws	
L_2	[mm]	Width of the locking device with screws	
Z		Number of clamping screws	
S		Size of the clamping screws	
M_A	[Nm]	Tightening torque of the clamping screws	

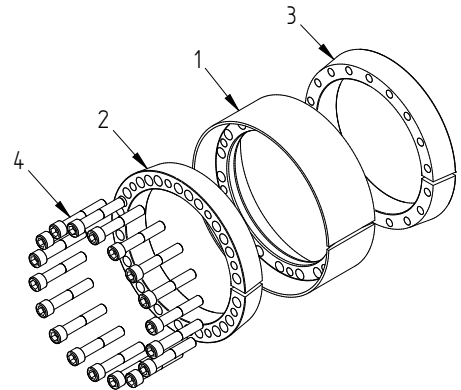

Recommended tolerances & surfaces

Shaft	h8 / Rz10
Hub	H8 / Rz10

Bending loads

Bending moment (share)	$M_B \text{ max} = 0,4 * M_t$
Bending angle	max. 5°

More properties

- low axial displacement during assembly
- good self-centering
- low self-locking

Pos.	Designation
1	Sleeve
2	Pressure ring 1
3	Pressure ring 2
4	Screw

Ordering information: TAS RB/d/D (e.g: TAS RB/150/200 ...
further sizes on request)

RB

d mm	x	D mm	M_t Nm	F_{ax} kN	p_w N/mm ²	p_N N/mm ²	Z Pcs.	S	M_A Nm	L mm	L₁ mm	L₂ mm	Weight kg
100	x	145	7800	157	80	46	7	M10 x 060	83	62	74	84	4,2
110	x	155	9800	180	83	50	8	M10 x 060	83	62	74	84	4,6
120	x	165	12100	202	83	51	9	M10 x 060	83	64	76	86	5,1
130	x	180	14600	225	85	52	10	M10 x 060	83	64	76	86	6,1
140	x	190	17300	247	84	52	11	M10 x 060	83	66	78	88	6,7
150	x	200	18500	247	73	53	11	M10 x 070	83	62	84	94	6,7
160	x	210	23900	299	75	48	9	M12 x 075	145	78	92	104	8,9
170	x	225	28200	332	79	50	10	M12 x 075	145	78	92	104	10,4
180	x	235	29800	332	79	50	10	M12 x 070	145	75	86	100	10,6
190	x	250	38100	401	67	50	9	M14 x 080	230	85	112	126	13,8
200	x	260	44500	446	70	54	10	M14 x 090	230	85	112	126	14,5
220	x	285	53900	490	74	54	11	M14 x 090	230	85	112	126	17,2
240	x	305	66000	551	76	56	9	M16 x 090	355	85	112	128	18,6
260	x	325	87400	673	75	57	11	M16 x 100	355	97	124	140	22,7
280	x	355	111000	795	72	55	13	M16 x 090	355	108	136	152	31,7
300	x	375	119000	795	73	52	13	M16 x 090	355	108	127	143	33,7
320	x	405	138000	865	65	47	15	M16 x 090	355	120	142	142	45,6
340	x	425	142000	841	60	44	15	M16 x 090	355	120	142	158	48,1
360	x	455	195000	1088	67	49	16	M18 x 130	485	130	160	178	62,1
380	x	475	235000	1240	67	48	13	M20 x 130	690	145	172	192	72,6
400	x	495	305000	1526	78	56	16	M20 x 130	690	145	172	192	76,0
420	x	515	320000	1526	69	54	16	M20 x 130	690	145	180	190	79,4
440	x	545	377000	1717	74	52	18	M20 x 130	690	160	180	200	102,0
460	x	565	394000	1717	71	56	18	M20 x 130	690	145	180	200	96,2
480	x	585	457000	1907	75	54	20	M20 x 130	690	160	180	200	110,3
500	x	605	476000	1907	72	60	20	M20 x 130	690	140	180	200	100,1
520	x	630	556000	2141	73	50	18	M22 x 140	930	180	202	224	140,4
540	x	650	610000	2260	74	51	19	M22 x 140	930	180	202	224	145,3
560	x	670	666000	2379	75	52	20	M22 x 140	930	180	202	224	150,2
580	x	690	632000	2180	66	47	20	M22 x 140	930	180	208	208	155,0
600	x	710	653000	2180	64	45	20	M22 x 140	930	180	208	230	159,9
620	x	730	585000	1888	78	62	21	M20 x 090	930	110	140	140	100,7