

SERIES C1100



- ✓ Absolute / relative positioning commands
- ✓ Limited jerk motion commands
- ✓ Time Curves
- ✓ PLC or Stand-Alone Solutions
- ✓ Digital and Analog IO's
- ✓ Safe Torque Off
- ✓ Interface for optional incremental or absolute sensor
- ✓ Supports Plug and Play
- ✓ CE / UL / CSA

Servo Drive C1100

Series C1100 servo drives are axis controllers, with 32-bit position resolution and an integrated power stage, for linear motors and rotary drives.

The controllers are suitable for simplest and standard positioning tasks with point to point motions.



CONNECTION TO MACHINE CONTROL

The C1100 servo drives can be actuated by machine controls from many manufacturers or brands, via digital inputs and outputs, over CAN Bus or Industrial Ethernet.

Bus-Interfaces:

- » Profinet
- » EtherCat, SoE, CoE
- » CANopen

Serial Interfaces RS422 / RS485:

- » LinRS

PROCESS AND SENSOR INTERFACES

Fast process interfaces for direct processing of sensor signals are available as freely programmable analog and digital inputs, a fast trigger input, and a capture input.

The safety IO's on Servo Drives with the -1S option with CAN or industrial ETH-ERNET allows safe torque off (STO) of the drives via control signals, without interrupting the power supply.

Drives with -0S option come without safety IO's and are easier to wire in applications without safety needs.

LOGIC AND POWER SUPPLY

The servo drives have two separate inputs for the logic supply and motor elements.

This has the advantage that the drive and linear motor do not need to be reinitialized when the machine is restarted, since all process data, including the actual position of the linear motor, is still up to date.

System Integration

Flexible hardware enables control of many 1/2/3-phase motors. Thus, low-power rotary servomotors, such as brushless DC motors, can be integrated in the same control concept.

Additionally, the drives can be equipped with optional peripherals, such as reference and end stop switches, high-precision external position sensors, or a mechanical holding brake.

Series C1100 servo drives have analog inputs and digital inputs and outputs, serial interfaces, CAN bus, and Ethernet. The user therefore is not dependent on the selection of the higher level controller. An appropriate interface is available, with associated protocols, for many PLC or IPC solution.

With flexibility and a compact form factor, LinMot Series C1100 servo drives provide a complete solution for a flexible drive concept in single and multiple axes applications, with linear motors and other actuators.

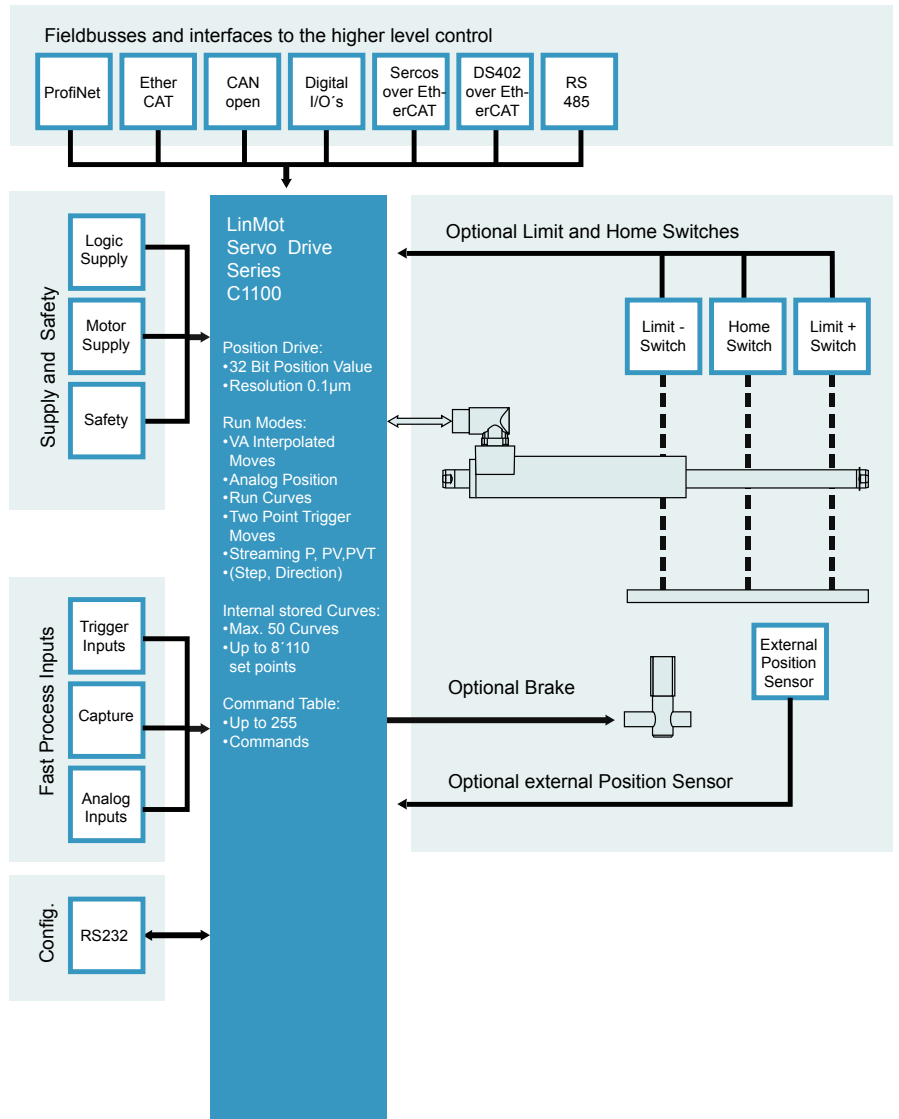

IDEAL FOR POINT TO POINT MOTIONS

Serial interfaces, CAN and industrial Ethernet guarantees flexible and fast communication.

The cost-optimized design of the C1100 series make it the ideal drive for point-to-point motions and replacement of pneumatic cylinders. The control is also characterized by higher speeds, longer service life and high flexibility.

MOTOR INTERFACES

C1100 servo drives provide all necessary interfaces to operate linear or rotary motors with optional external peripherals, such as end position and reference switches, a mechanical brake, or a high-resolution external position sensor.

CONFIGURATION

LinMot Talk, a user-friendly PC software is available for configuration. In addition to online documentation, LinMot Talk provides extensive debugging tools, such as an oscilloscope and an error inspector, for simple and rapid start-up of the Axis.

Fieldbus and Ethernet drives can also be configured directly by the higher level control, by downloading the configuration parameters via Bus/Ethernet

CONNECTION TO MACHINE DRIVE

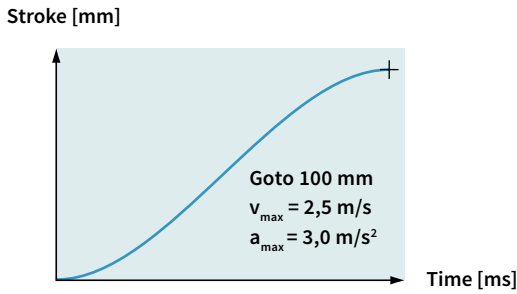

For direct position targets, using absolute or relative positioning, the desired position is reached using acceleration and velocity-limited motion profiles, sine motion profiles or jerk optimized profiles (jerk limited Bestehorn). Positioning commands can be invoked via the serial interfaces, CANopen, Ethernet or a trigger input.

Stroke range:	±100 m
Position Resolution:	0.1 µm (32Bit)
Velocity Resolution:	1.0 µm/s (32Bit)
Acceleration Resol.:	10.0 µm/s ² (32Bit)

TIME CURVES

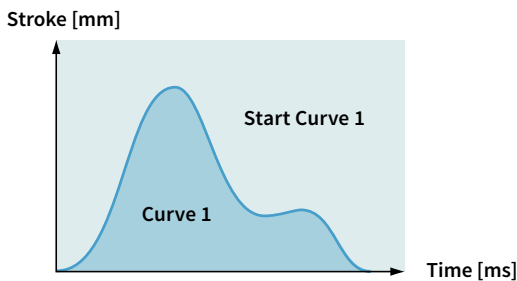

Up to 50 different time curves can be stored Series C1100 drives, with up to 8'110 individual waypoints. The motor can thus travel along time curves of any complexity, such as those generated by CAD programs and stored in the drive (Excel CSV format). The time curves can be invoked via the serial interface, fieldbuses, Ethernet, or the trigger input.

Stroke range:	±100m
Position Resolution:	0.1 µm (32Bit)
Motion profiles:	Max. 50 Time Curves
Curve points:	Max. 8'110 points

11

PROFILED MOVES

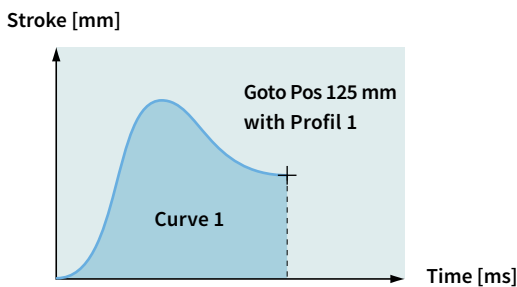

For travel to an absolute position, or shifting by a relative position, any desired motion rules can be stored besides the VA interpolator. They are stored in the drive as motion profiles (Excel CSV format). The positions can be approached, for example, with a sinusoidal motion to optimize power loss, or special reverse optimized motion profiles.

Stroke range:	±100m
Position Resolution:	0.1 µm (32Bit)
Motion profiles:	Max. 50 Time Curves
Curve points:	Max. 8'110 points

SETPOINT STREAMING

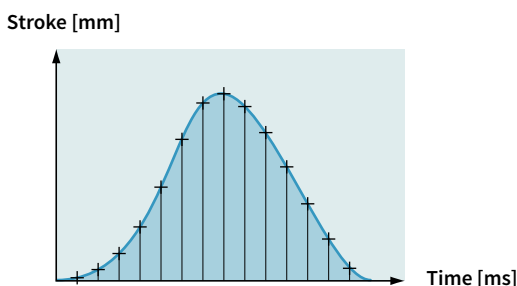

Higher level NC motion controllers with fieldbus or Ethernet interfaces communicate with the servo drives via "Position Streaming". The position and velocity calculated in the higher level control is transmitted to the Servo Drive cyclically. The P, PV, or PVT mode is available for this transmission.

Position Resolution:	32 Bit
Velocity Resolution:	32 Bit
Interpolator:	4 kHz
Cycle times:	0.5 - 5 ms

EASY STEPS

Input 1	Pos 125 mm
Input 2	Pos 250 mm
Input 3	Curve 1
Input 4	Pos -30 mm

With the Easy Steps function, up to 4 positions or independent travel commands can be stored on the drive, and addressed via 4 digital inputs or fieldbus interfaces/Ethernet.

Digital inputs: 4
Interface: X4
Scanning rate: 250 µsec

COMMAND TABLE

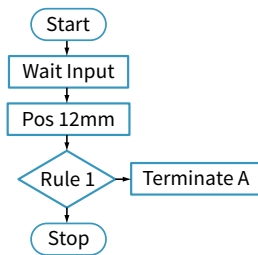

Entire motion sequences with up to 255 individual motion commands can be stored in the Command Table. This is primarily advantageous if complete motion sequences need to be executed very quickly, without dead time from the higher level drive. In the Command Table, the programmer has access to all motion commands, internal parameters, and digital inputs and outputs.

Commands: max. 254
Cycle time: 250 µsec

ANALOG POSITION

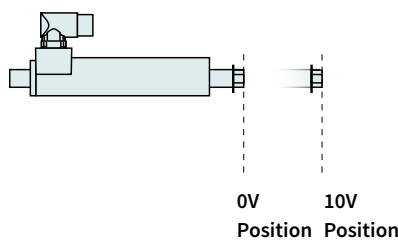

For an analog position target, the linear motor travels to a position proportional to the input voltage. The position is either scanned continuously, or only after a rising edge of the trigger signal. In order to prevent uncontrolled jumps in position, the motor travels to the positions with a programmable maximum acceleration and velocity (VA interpolator).

Inputs: Analog Input X4
Voltage range: 0-10VDC or ±10V
Resolution: 10 Bit
Scanning rate: >=250 µsec (adjustable)

EASY STEPS PARAMETER SCALE

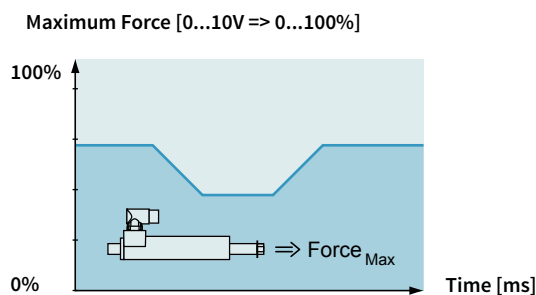

Easy Steps provide the ability to parameterize internal parameters using two analog inputs. If, for example, the maximum motor current is read at an analog input, then the maximum motor force can be provided as analog for freely programmable joining processes.

Inputs: 2 x Analog
Voltage range: 0-10VDC
Resolution: 10 Bit
Scanning rate: 250 µsec

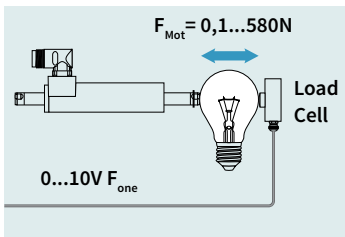
CLOSED LOOP FORCE CONTROL

Using the force control technology function, precise joining processes can be implemented reliably and reproducibly with high-precision force control. For force control, the current motor force is measured with a load cell and controlled in the drive. Joining process or quality checks with high requirements for applied force can be implemented.

Analog input:	0-10V or $\pm 10V$
Resolution:	10 Bit
Min. Force Resolution:	0.1N

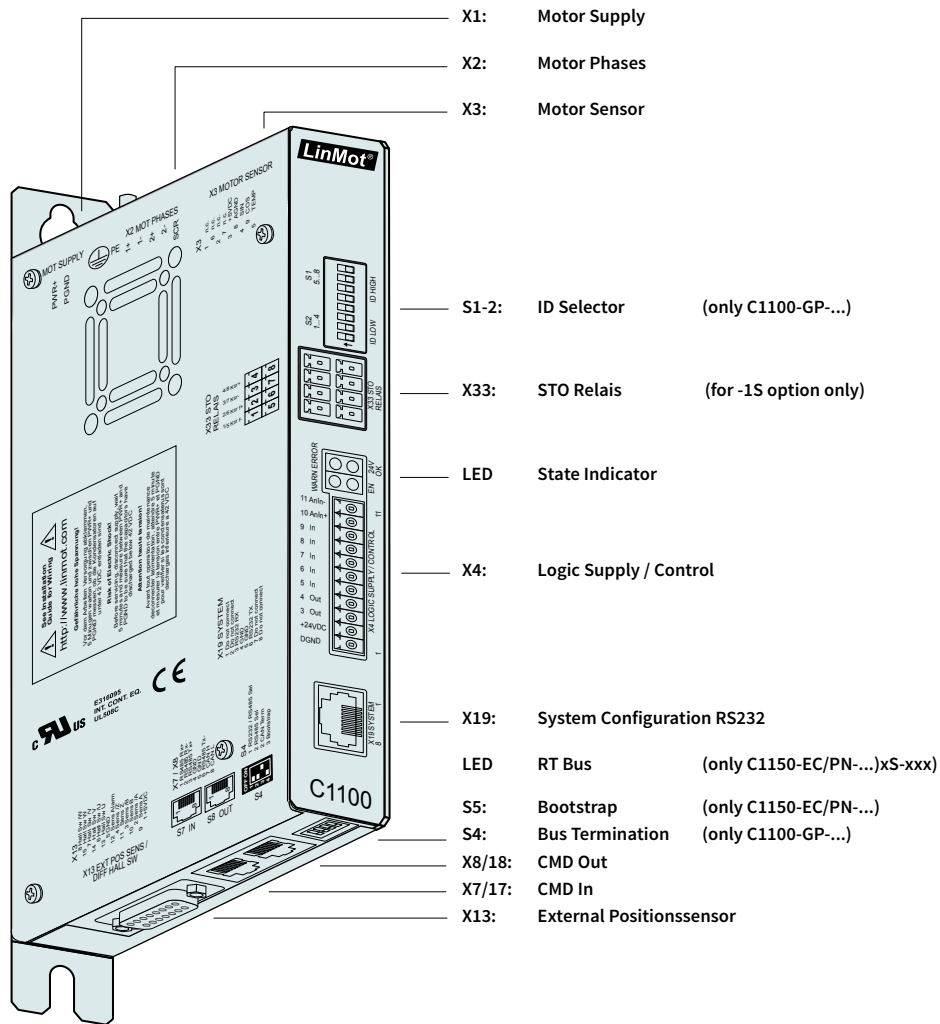

Interfaces	C1100-GP-XC	C1150-EC-XC	C1150-DS-XC	C1150-SE-XC	C1150-PN-XC
LinRS (RS485 / RS422)	•				
CANOpen	•				
ETHERCAT LinMot Profile		•			
ETHERCAT CiA402			•		
ETHERCAT SoEe				•	
PROFINET LinMot					•

C1100-GP-XC-0S C1100-GP-XC-1S

- » Absolute & Relative Positioning
- » Time based motion profiles
- » Internally stored Motion Sequences
- » Position Streaming
- » Analog Position Target
- » Analog Parameter Scaling
- » Force Control Technology Function
- » Customer-Specific Functions

CANopen

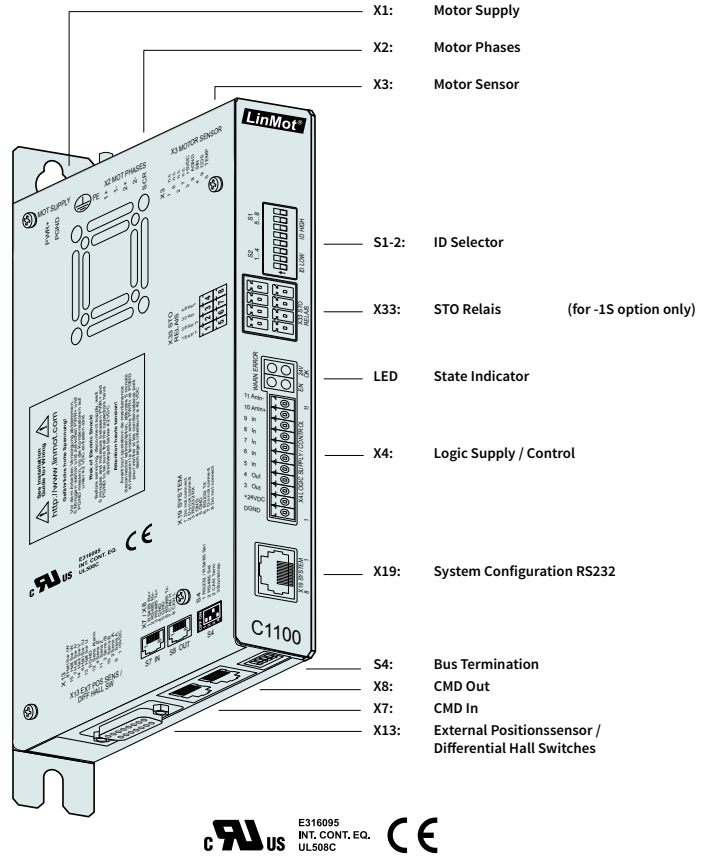

11

CANOPEN

The LinMot C1100-GP drives support the CiA DS301 communications protocol. The following resources are available:

4 T_PDO, 4 R_PDO, 1 T_SDO, 1 R_SDO

The following protocols are supported by the CO drives:

- » NMT Error Control (Nodeguarding Protocol or HeartBeat Protocol)
- » PDO (Transmission type 1 to 254)
- » SDO Upload and Download
- » NMT (Start, Stop, Enter PreOp, Reset Node, Reset Communication, Boot-Up Message)

PROCESS AND SENSOR INTERFACES

C1100-GP servo drives support the following interfaces:

- » CANOpen
- » LinRS

MINIMAL CYCLE TIMES

Min. Bus Cycle:	500 µs
IO update:	500 µs
Trigger Input:	250 µs
Position control loop:	250 µs
Current control loop:	125 µs

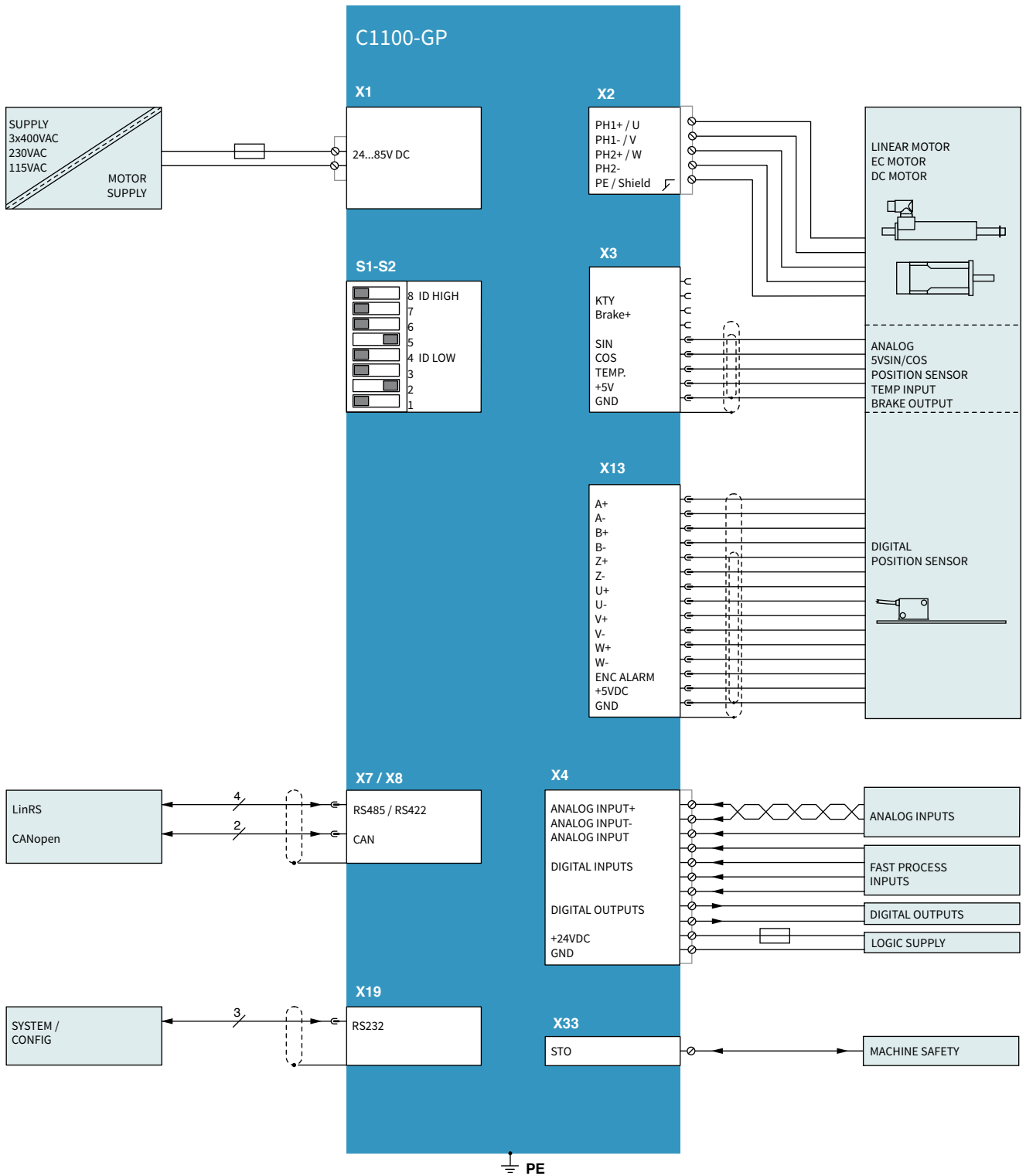

C1150-xx-XC-xS-xxx



- » Absolute & Relative Positioning
- » Time based motion profiles
- » Internally stored Motion Sequences
- » Position Streaming
- » Analog Position Target
- » Analog Parameter Scaling
- » Force Control Technology Function
- » Customer-Specific Functions

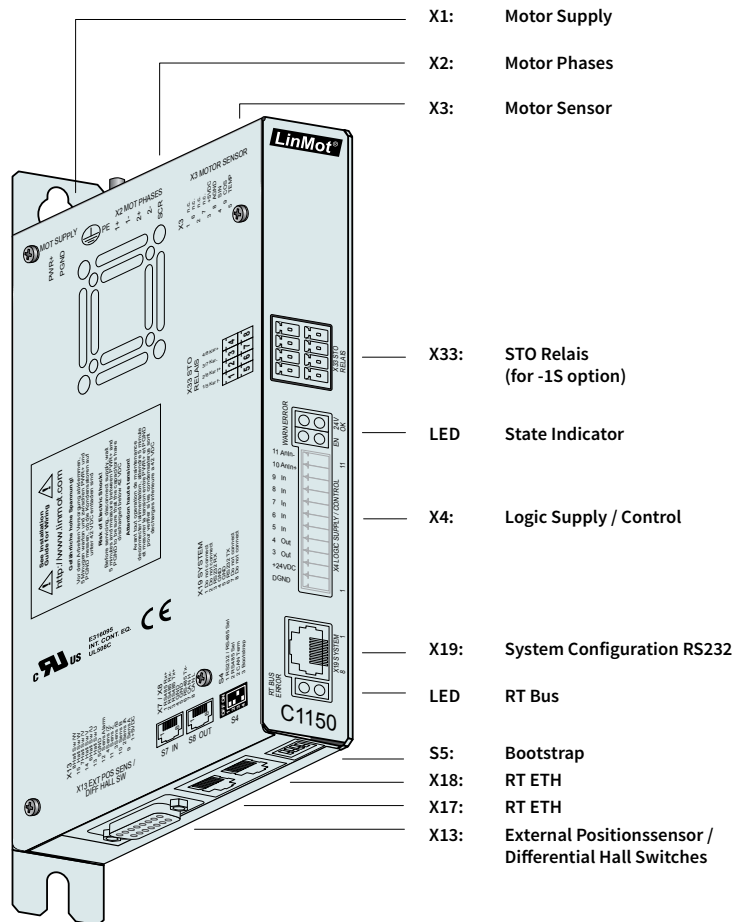

INDUSTRIAL ETHERNET

Series C1150-EC drives allow integration of LinMot linear motors in controls concepts with EtherCAT. The user can integrate Series C1100 drives regardless of the provider of the higher level control.

LinMot drives are available with common industrial Ethernet protocols. Since all Ethernet drives have the same motion command interface, and the control and status word are identical, software blocks that have been implemented once, can be transferred to other motion controllers without a problem.

TECHNICAL DATA

Type: Realtime Ethernet
 Switch/Hub: Integrated 2-Port Switch
 Transfer rate: 10/100MBit/sec

MINIMAL CYCLE TIMES

Bus cycle: 500 μ s
 IO update: 500 μ s
 Trigger Input: 250 μ s
 Position control loop: 250 μ s
 Current control loop: 125 μ s

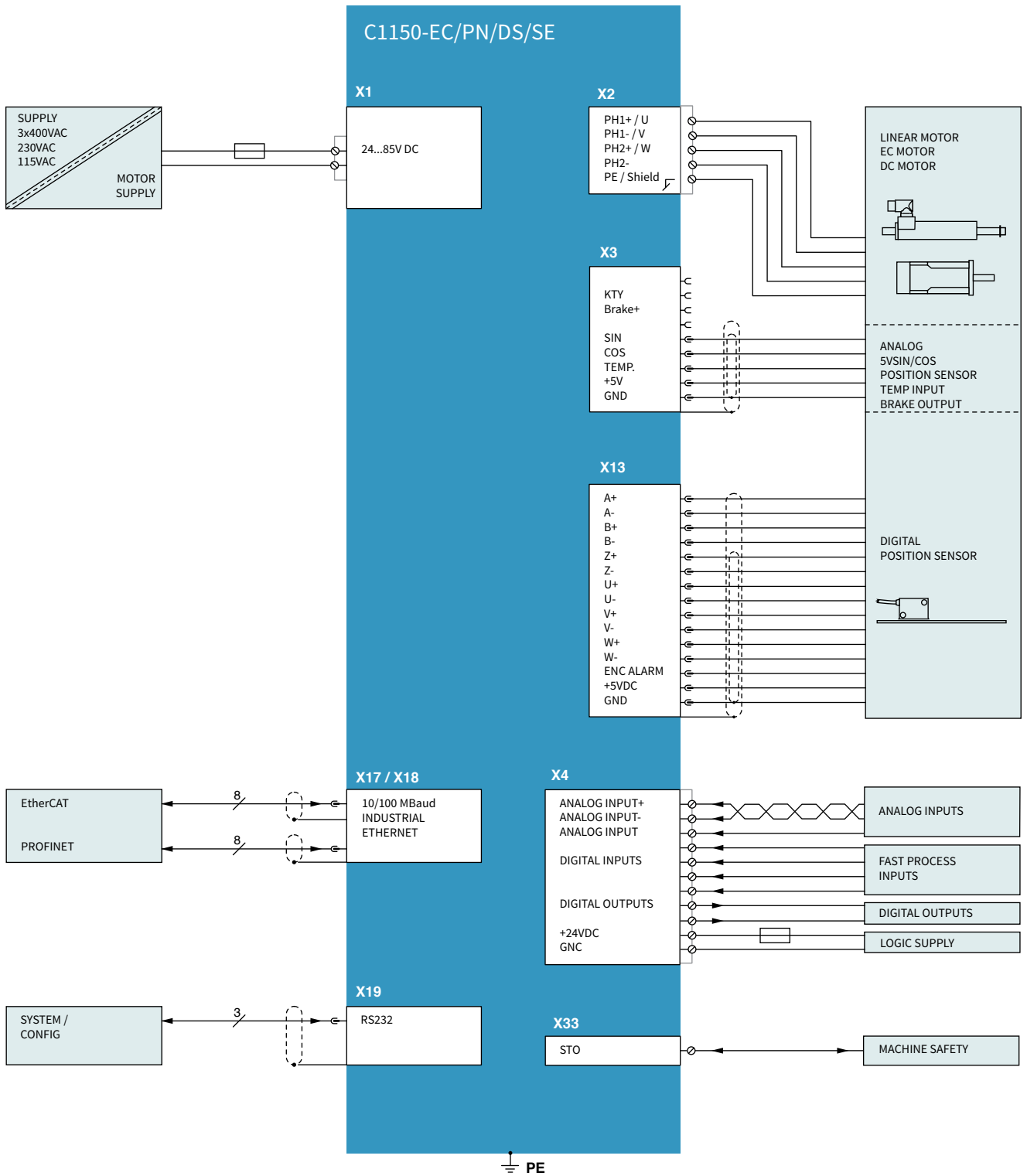

X1 MOTOR SUPPLY

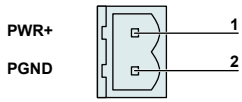

Connector has to be ordered separately

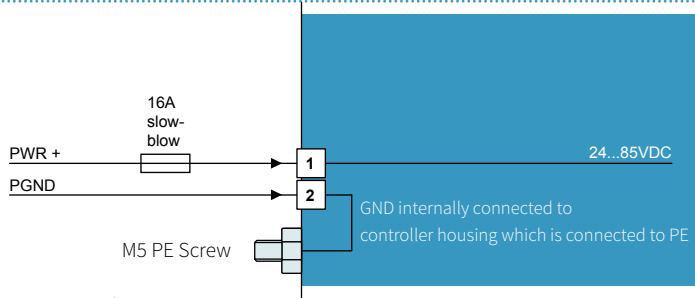

Motor Supply: 72VDC nominal, 24...85VDC
 Absolute max. Rating: 72VDC +20%.
 External Fuse: 16A slow-blow / min. 100VDC
 If motor supply voltage exceeds 90VDC, the drive will go into error state.

- » Use 60/75°C copper conductors only
- » Conductor Cross-Section 2.5mm² (AWG14) max Length 3 m

X2 MOTOR PHASES

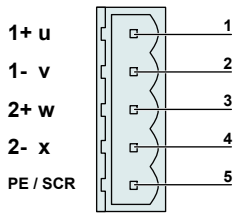

Connector has to be ordered separately

Nr	Designation	LinMot Linear Motor	Color	3-phase EC-Motor	Color
1	PH1+	Motor Phase 1+	red	Motor Phase U	red
2	PH1-	Motor Phase 1-	pink	Motor Phase V	pink
3	PH2+	Motor Phase 2+	blue	Motor Phase W	blue
4	PH2-	Motor Phase 2-	grey	RR-	grey
5	PE/SCRN	Shield		Shield	

- » Use 60/75°C copper conductors only
- » Conductor cross-section: 0.5 – 2.5mm² (depends on Motor current) / AWG 21 -14

X3 MOTOR SENSOR / BREMSE

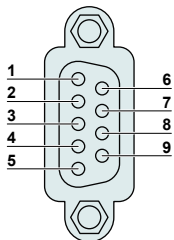

DSUB-9

Nr		LinMot Motor	EC Motor
1		Do not connect	Do not connect
	6	Brake+	Brake+
2		Do not connect	Do not connect
	7	Do not connect	KTY
	3	+5VDC	+5VDC
	8	AGND	AGND
4		Sensor Sine	Sensor Sine / Hall Switch U
	9	Sensor Cosine	Sensor Cosine / Hall Switch V
5		Temp In	Hall Switch W
	Case	Shield	Shield

- » Use +5V (X3.3) and AGND (X3.8) only for motor internal Hall Sensor supply (max. 100 mA)
- » Cable length < 30 m
- » Brake+: 24V 500mA, 1.4A_{peak}
- » Caution: Do NOT connect AGND (X3.8) to ground or earth!

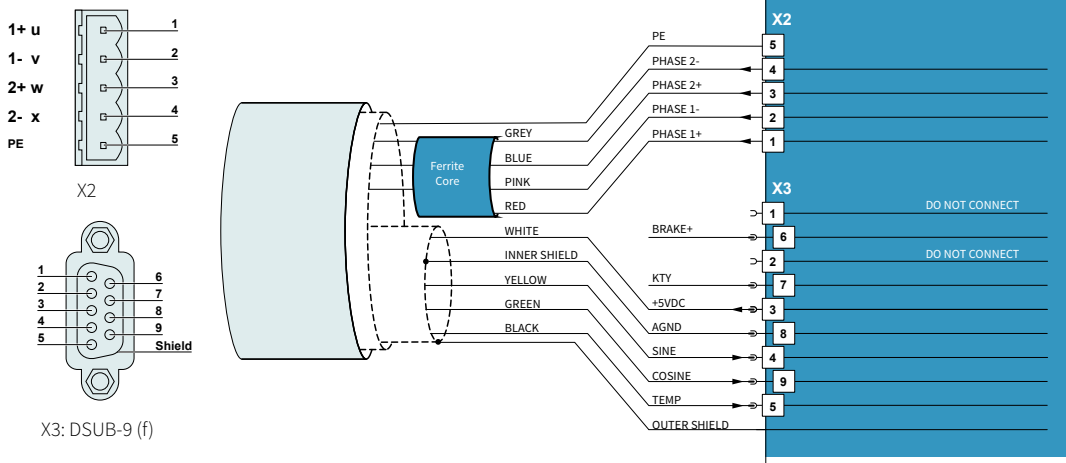

Use Y-style motor cables only (for example K15-Y/C)!

A W-style cable has a different shielding, so it cannot be modified to a Y-style cable!

Phase 2-could be used as RR-with3 phase Motors the other side of regeneration resistor has to be wired to PWR

X4 LOGIC SUPPLY / IO CONNECTION



DSUB-9 (f)
Spring cage connector (has to be ordered separately)

Nr			
11	AnIn-	X4.11	Configurable Analog Input differential (with X4.10)
10	AnIn+	X4.10	Configurable Analog Input differential (with X4.11)
9	AnIn	X4.9	Configurable Analog Input single ended
8	In	X4.8	Configurable Input
7	In	X4.7	Configurable Input
6	In	X4.6	Configurable Input
5	In	X4.5	Configurable Input
4	Out	X4.4	Configurable Output
3	Out	X4.3	Configurable Output
2	+24VDC	Supply	Logic Supply 22-26 VDC
1	GND	Supply	Ground

Inputs: (X4.5...X4.8)
Outputs: (X4.3 & 4.4)
Analog inputs:
X4.9:
X4.10/X4.11:

Supply 24V:

24V / 5mA (Low Level: -0.5 to 5VDC, High Level: 15 to 30VDC)
 24V / max. 500mA, Peak 1.4A (will shut down if exceeded)
 10 bit A/D converted.
 Single ended analog input to GND, 0..10V, Input Resistance: 51kΩ to GND
 Differential analog input, +/- 10V. Common mode range: +/- 5VDC to GND.
 Input Resistance: 11.4kΩ for each signal to GND
 typically 200mA / max. 2.0A (if all outputs "on" with max. load.)
 » Use 60/75°C copper conductors only
 » Conductor cross-section max. 1.5 mm²
 » Stripping length: 10 mm
 » The 24VDC supply for the control circuit (X4.2) must be protected with an external fuse (3A slow blow)

X7 - X8 RS485 / CAN (ON GP DRIVES ONLY)

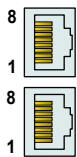

RJ-45

Nr		
1	RS485_Rx+	A
2	RS485_Rx-	B
3	RS485_Tx+	Y
4	NC	
5	GND (1k Ohm to GND)	
6	RS485_Tx-	Z
7	CAN_H	
8	CAN_L	
Case	Shield	

- » Use twisted pair (1-2, 3-6, 4-5, 7-8) cable for wiring.
- » The built in CAN and RS485 terminations can be activated by S4.2 and S4.3.
- » X7 is internally connected to X8 (1:1 connection)

S1 - S2 ADDRESS SELECTORS (ON GP DRIVES ONLY)



S1 (5..8)	Bus ID High (0 ... F). Bit 5 is the LSB, bit 8 the MSB.
-----------	---

S2 (1..4)	Bus ID Low (0 ... F). Bit 1 is the LSB, bit 4 the MSB
-----------	---

The use of these switches depends on the type of fieldbus which is used. Please see the corresponding manual for further information.

RT BUS LEDS



RT BUS State Display	
Green	OK
Red	Error

The use of these LEDs depends on the type of fieldbus which is used. Please see the corresponding manual for further information.

S4 BUS TERMINATION (ON GP DRIVES ONLY)



Switch 4	Bootstrap
Switch 3	Termination CAN on/off
Switch 2	Termination RS485 on/off
Switch 1	RS232 / RS485

Factory settings: Switch 3 “on”, all other switches “off”

S5 BOOTSTRAP (ON EC AND PN DRIVES ONLY)

S5	Bootstrap (Internal use only)
----	-------------------------------

X13 EXTERNAL POSITION SENSOR DIFFERENTIAL HALL SWITCHES

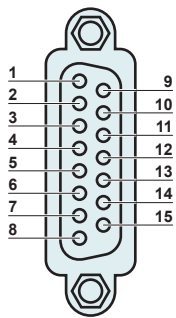

DSUB-15 (f)

Nr	ABZ with Hall Switches	SSI / BiSS
1	+5V DC	+5V DC
2	A+	A+
3	A-	A-
4	B+	B+
5	B-	B-
6	Z+	Data+
7	Z-	Data-
8	Encoder Alarm	Encoder Alarm
9	GND	GND
10	U+	nc
11	U-	nc
12	V+	nc
13	V-	nc
14	W+	Clk+
15	W-	Clk-
Case	Shield	Shield

Position Encoder Inputs (RS422):

Differential Hall Switch Inputs (RS422):

Enc. Alarm In:

Sensor Supply:

Max. counting frequency: 10 Mcounts/s with quadrature decoding, 100ns edge separation

Input Frequency: <1kHz

5V / 1mA

5VDC, max 100mA

X33 SAFETY RELAYS (ONLY FOR -1S)

X33. 4/8 Ksr+
 X33. 3/7 Ksr-
 X33. 2/6 Ksr f+
 X33. 1/5 Ksr f-

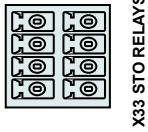

Spring cage connector
 (has to be ordered
 separately)

Nr		
4 / 8	Ksr +	Safety Relay 1 / 2 Input positive
3 / 7	Ksr -	Safety Relay 1 / 2 Input negative
2 / 6	Ksr f+	Safety Relay 1 / 2 feedback positive
1 / 5	Ksr f-	Safety Relay 1 / 2 feedback negative

- » Use 60/75°C copper conductors only
- » Conductor cross-section max. 1.5 mm²
- » Stripping length: 10 mm
- » Never connect the safety relays to the logic supply of the drive!

X17 - X18 REALTIME ETHERNET 10/100 MBIT/S (ON EC AND PN DRIVES ONLY)

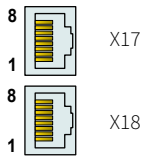

RJ-45

Nr		
X17	RT ETH In	Specification depends on RT-Bus. Please refer to according documentation.
X18	RT ETH Out	

LEDS STATE DISPLAY



Green	24V Logic Supply OK
Yellow	Motor Enabled / Error Code Low Nibble
Yellow	Warning / Error Code High Nibble
Red	Error

X19 SYSTEM

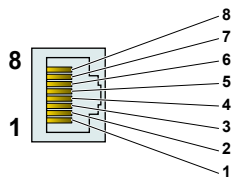

RJ-45

Nr	Description
1	(do not connect)
2	(do not connect)
3	RS232 RX
4	GND
5	GND
6	RS232 TX
7	(do not connect)
8	(do not connect)
case	Shield

Use isolated USB-RS232 converter (Art.-No. 0150-2473) for configuration over RS232

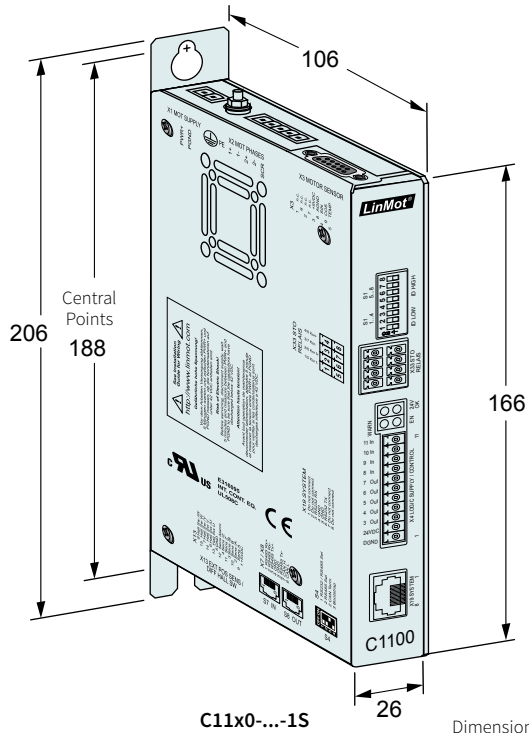
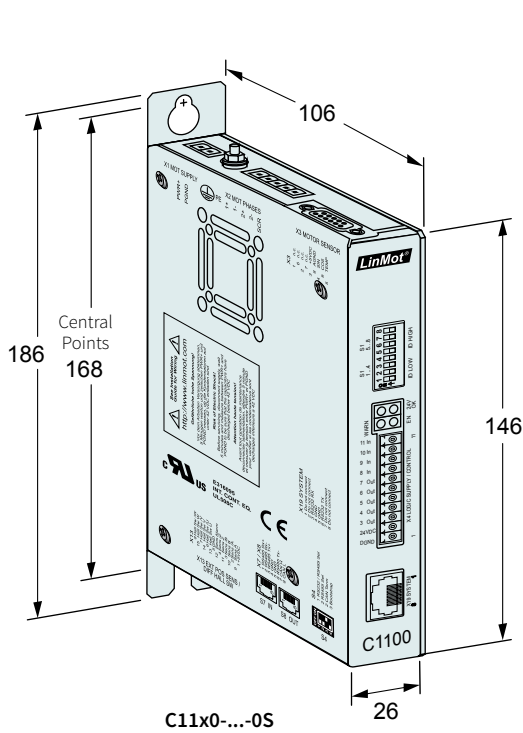

Dimensions in mm
Mounting points for M5 screws

Servo Drive Series		C11x0-...-0S	C11x0-...-1S
Width	mm (in)		26.0 (1.02)
Height	mm (in)	146 (5.8)	166 (6.5)
Height with fixings	mm (in)	186 (7.3)	206 (8.1)
Depth	mm (in)		106 (4.2)
Weight	kg (lb)	505 (1.21)	650 (1.43)
Mounting Screws		2 x M5	2 x M5
Mounting Distance	mm (in)	168 (6.61)	188 (7.4)
Case IP Code	IP		20
Storage temperature	°C		-25...40
Transport temperature	°C		-25...70
Operating temperature	°C		0...40 at rated date 40...50 with power derating
Relative humidity			95% (non-condensing)
Pollution	IEC/EN 60664-1		Pollution degree 2
Shock resistance (16 ms)	-1S option		3.5 g
Vibration resistance (10-200Hz)	-S option		1 g
Max. case temperature	°C		70
Max. power dissipation	W		30
Mounting place			in the control cabinet
Mounting position			vertical
Distance between Drives	mm (in)		Without Power Derating 20 (0.8) left/right / 50 (2) top/bottom With Power Derating: 5 (0.2) left/right / 20 (0.8) top/bottom

Servo Drives		
Item	Description	Part Number
C1100-GP-XC-0S-000	General Purpose Drive (72VDC/25)	0150-2380
C1150-PN-XC-0S-000	ProfiNet Drive (72V/25A)	0150-2384
C1150-EC-XC-0S-000	EtherCAT Drive (72VDC/25A)	0150-2382
C1150-DS-XC-0S-000	EtherCAT CoE Drive (72VDC/25A)	0150-2417
C1150-SE-XC-0S-000	EtherCAT SoE Drive (72VDC/25A)	0150-2625
C1100-GP-XC-1S-000	General Purpose Drive (72VDC/25), STO	0150-2381
C1150-PN-XC-1S-000	ProfiNet Drive (72V/25A), STO	0150-2385
C1150-EC-XC-1S-000	EtherCAT Drive (72VDC/25A), STO	0150-2383
C1150-DS-XC-1S-000	EtherCAT CoE Drive (72VDC/25A), STO	0150-2418
C1150-SE-XC-1S-000	EtherCAT SoE Drive (72VDC/25A), STO	0150-2626

Accessories		
Item	Description	Part Number
DC01-C1X00-0S/X1/X4	Drive Connector Set for C1X00-0S	0150-3527
DC01-C1X00-1S/X1/X4/X33	Drive Connector Set for C1X00-1S	0150-3528
DC01-C1X00/X1	Drive Connector for PWR 72VDC Input	0150-3525
DC01-C1X00/X2	Drive Connector Motor Phases	0150-3526
DC01-Signal/X4	Drive Connector 24VDC & Logic	0150-3447
DC01-Safety/X33 yello	Drive Connector Safety	0150-3451